



HP79XEx Intrinsically Safe Digital Portable Radio User Manual

Preface

Welcome to the world of Hytera and thank you for purchasing this product. This manual includes a description of the functions and step-by-step procedures for use.

To avoid bodily injury or property loss caused by incorrect operation, please carefully read the *Safety Information Booklet* before use.

This manual is applicable to the following product:

HP79XEx Intrinsically Safe Digital Portable Radio

Copyright Information

Hytera is the trademark or registered trademark of Hytera Communications Corporation Limited (the Company) in the People's Republic of China (PRC) and/or other countries or areas. The Company retains the ownership of its trademarks and product names. All other trademarks and/or product names that may be used in this manual are properties of their respective owners.

The product described in this manual may include the Company's computer programs stored in memory or other media. Laws in PRC and/or other countries or areas protect the exclusive rights of the Company with respect to its computer programs. The purchase of this product shall not be deemed to grant, either directly or by implication, any rights to the purchaser regarding the Company's computer programs. The Company's computer programs may not be copied, modified, distributed, decompiled, or reverse-engineered in any manner without the prior written consent of the Company.

Disclaimer

The Company endeavors to achieve the accuracy and completeness of this manual, but no warranty of accuracy or reliability is given. All the specifications and designs are subject to change without notice due to continuous technological development. No part of this manual may be copied, modified, translated, or distributed in any manner without the prior written consent of the Company.

We do not guarantee, for any particular purpose, the accuracy, validity, timeliness, legitimacy or completeness of the third-party products and contents involved in this manual.

If you have any suggestions or would like to receive more information, please visit our website at: <https://www.hytera.com>.

Contents

Documentation Information	1
1. Intrinsically Safe Radio Information	2
1.1 Compliance Standards	2
1.2 Product Marking	2
1.2.1 IIC Product Marking	2
1.2.2 IIA Product Marking	3
1.3 Specific Conditions of Use	4
1.4 Connection with Other Intrinsically Safe Equipment Specific Conditions of Use	5
1.5 Warnings.....	5
1.6 Caution	6
1.7 No Misoperations.....	6
1.8 Maintenance	7
1.9 Training Instructions	7
1.10 Hazardous Area Classification	7
2. Packing List	11
3. Product Overview.....	12
3.1 Product Layout	12
3.2 Programmable Keys	13
4. Before Use	14
4.1 Attach the Battery	14
4.2 Charge the Battery	15
4.3 Attach the Antenna.....	15
4.4 Attach the Audio Accessory	16
4.5 Attach the Belt Clip.....	17
4.6 Install the TF Card.....	18
5. Basic Operations.....	19
5.1 Turn On or Off the Radio.....	19
5.2 Adjust the Volume	19
5.3 Select Contact or Channel	19
5.4 Lock or Unlock the Keypad	19
5.5 Understand Keypad Operations.....	20
5.6 Switch the Operation Mode	20
5.6.1 Conventional Mode	20
5.6.2 Trunking Mode	21
6. Status Indications	22
6.1 LCD Icons.....	22
6.2 LED Indicator.....	23

7. Call Services	25
7.1 Group Call.....	25
7.1.1 Initiate a Group Call	25
7.1.2 Answer a Group Call	26
7.1.3 End a Group Call.....	26
7.2 Private Call	27
7.2.1 Initiate a Private Call	27
7.2.2 Answer a Private Call	28
7.2.3 End a Private Call	28
7.3 All Call.....	29
7.3.1 Initiate an All Call.....	29
7.3.2 Answer an All Call	30
7.3.3 End an All Call.....	30
7.4 Broadcast Call (Trunking Only)	31
7.4.1 Initiate a Broadcast Call	31
7.4.2 Answer a Broadcast Call	32
7.4.3 End a Broadcast Call	32
7.5 Include Call (Trunking Only).....	32
7.6 Phone Call	32
7.6.1 Initiate a Phone Call	32
7.6.2 Answer a Phone Call.....	33
7.6.3 End a Phone Call	33
7.7 Call on Analog Channel.....	34
7.7.1 Call Without Signaling	34
7.7.2 Call with Signaling	34
8. Message Services	35
8.1 Send a Message.....	35
8.1.1 Through Message	35
8.1.2 Through Contact.....	35
8.2 Reply to a Message.....	36
8.3 Edit a Message.....	36
9. Supplementary Features	37
9.1 Settings.....	37
9.1.1 Basic Settings.....	37
9.1.2 Call Settings	39
9.1.3 Security	41
9.1.4 Check the Product Information	45
9.2 Contacts.....	45
9.2.1 Create a Contact	45

9.2.2 Edit a Favorite Contact.....	46
9.2.3 Priority Group (Trunking Only)	46
9.3 Profiles.....	46
9.3.1 Switch the Profile	47
9.3.2 Set the Alert Tone.....	47
9.3.3 Mic AGC	47
9.3.4 Audio Mode	47
9.4 Scan.....	48
9.4.1 Conventional Mode	48
9.4.2 Trunking Mode	49
9.5 Positioning	50
9.5.1 Turn on the Positioning Feature.....	51
9.5.2 Select the Positioning System	51
9.5.3 View the Position.....	51
9.5.4 Send a Position Message	51
9.5.5 Call Location.....	52
9.6 BT	53
9.6.1 Connect a BT Device	53
9.6.2 BT Audio Switch	54
9.6.3 Set the BT	54
9.6.4 BT Location	54
9.7 One Touch Call/Menu	54
9.8 Quick Dial	55
9.9 Roam	56
9.9.1 Conventional Mode	56
9.9.2 Trunking Mode	56
9.10 DGNA	56
9.11 Priority Interrupt.....	57
9.11.1 Manual Priority Interrupt.....	57
9.11.2 Auto Priority Interrupt.....	57
9.12 Emergency	57
9.12.1 Initiate an Emergency Call	58
9.12.2 Answer an Emergency Call.....	58
9.12.3 End an Emergency Call	58
9.13 Stun, Revive, and Kill	58
9.14 Emergency Erase Data	59
10. Troubleshooting.....	60
11. Radio Care	63
11.1 Care	63

11.2 Cleaning..... 64

11.3 Sterilizing 65

11.4 Storing 65

12. Optional Accessories 66





13. Specifications 67

14. Abbreviations 69

Documentation Information

Documentation Conventions

Instruction Conventions

Icon	Description
 TIP	Indicates information that can help you make better use of your product.
 NOTE	Indicates references that can further describe the related topics.
 CAUTION	Indicates situations that could cause data loss or equipment damage.
 WARNING	Indicates situations that could cause minor personal injury.
 DANGER	Indicates situations that could cause major personal injury or even death.

Notation Conventions

Item	Description	Example
Boldface	Denotes menus, tabs, parameter names, window names, dialogue names, and hardware buttons.	To save the configuration, click Apply .
		The Log Level Settings dialog box appears.
		Press the PTT key.
" "	Denotes messages, directories, file names, folder names, and parameter values.	The screen displays "Invalid Battery!".
		Open "PSS.exe".
		Go to "D:/opt/local".
>	Directs you to access a multi-level menu.	In the Port text box, enter "22".
		Go to File > New .
		For details about using the DWS, refer to <i>Dispatch Workstation User Guide</i> .
<i>Italic</i>	Denotes document titles.	To set the IP address, run the following command:
Courier New	Denotes commands and their execution results.	<code>vos-cmd - m name IP</code>

1. Intrinsically Safe Radio Information

CAUTION

- Observe the following safety instructions when using the radio, so as to ensure safe and reliable operations. Failure to observe the instructions may result in danger or violation of applicable regulations.
- To avoid possible interference with blasting operations, keep the radio turned off when you are near electrical blasting caps, in a blasting area, or in areas posted "Turn off two-way radios". Obey all signs and instructions.

1.1 Compliance Standards

This radio complies with the following standards:

Standard	Edition	Issue Date
IECEX (International)		
IEC 60079-0	Edition 7.0	2017
IEC 60079-11	Edition 6.0	2011
ATEX (EU)		
EN 60079-0	Edition 7.0	2018
EN 60079-11	Edition 6.0	2012
NEC (US)		
ANSI/UL 60079-0	Edition 7.0	2019
ANSI/UL 60079-11	Edition 6.2	2018
CEC (CA)		
CAN/CSA C22.2 No. 60079-0	Edition 4.0	2019
CAN/CSA C22.2 No. 60079-11	Edition 6.0	2011

1.2 Product Marking

1.2.1 IIC Product Marking

The explosion-proof certification and rating of the radio are displayed in the following table:

Certificate No.	Marking
IECEX FMG 23.0016X	Ex ib I Mb Ex ib IIC T4 Gb Ex ib IIIC T120 °C Db IP66/IP68, -25°C≤Ta≤+60°C
FM23ATEX0033X	I M2 Ex ib I Mb II 2G Ex ib IIC T4 Gb II 2D Ex ib IIIC T120 °C Db IP66/IP68, -25°C≤Ta≤+60°C
FM23UKEX0036X	I M2 Ex ib I Mb II 2G Ex ib IIC T4 Gb II 2D Ex ib IIIC T120 °C Db IP66/IP68, -25°C≤Ta≤+60°C
FM23US0069X	Class I, Zone 1, AEx ib IIC T4 Gb Zone 21, AEx ib IIIC T120 °C Db IP66/IP68, -25°C≤Ta≤+60°C
FM23CA0051X	Ex ib IIC T4 Gb Ex ib IIIC T158 °C Db IP66/IP68, -25°C≤Ta≤+60°C

1.2.2 IIA Product Marking

The explosion-proof certification and rating of the radio are displayed in the following table:

Certificate No.	Marking
IECEX FMG 23.0016X	Ex ib I Mb Ex ib IIC T4 Gb Ex ib IIIC T120 °C Db IP66/IP68, -25°C≤Ta≤+50 °C
FM23ATEX0033X	I M2 Ex ib I Mb II 2G Ex ib IIC T4 Gb II 2D Ex ib IIIC T120 °C Db IP66/IP68, -25°C≤Ta≤+50 °C
FM23UKEX0036X	I M2 Ex ib I Mb II 2G Ex ib IIC T4 Gb II 2D Ex ib IIIC T120 °C Db

Certificate No.	Marking
	IP66/IP68, $-25^{\circ}\text{C} \leq \text{Ta} \leq +50^{\circ}\text{C}$
FM23US0069X	Class I, Zone 1, AEx ib IIC T4 Gb Zone 21, AEx ib IIIC T120 °C Db IP66/IP68, $-25^{\circ}\text{C} \leq \text{Ta} \leq +50^{\circ}\text{C}$
FM23CA0051X	Ex ib IIC T4 Gb Ex ib IIIC T158 °C Db IP66/IP68, $-25^{\circ}\text{C} \leq \text{Ta} \leq +50^{\circ}\text{C}$

1.3 Specific Conditions of Use

- The radio shall only be used with Lithium-ion rechargeable battery pack identified as Hytera Communications Co., Ltd. part number BL2105-Ex.
- Recharging of the Lithium-ion rechargeable battery pack shall only be performed in the non-hazardous area with a maximum ambient of 45°C using only battery chargers identified as Hytera Communications Co., Ltd. part numbers CH10L33, CH20L24, or MCL41.
- The radio shall only be used with optional remote speaker microphone accessory identified as Hytera Communications Co., Ltd. part number SM26N13P-Ex.
- The radio shall only be used with optional earpiece and microphone accessory identified as Hytera Communications Co., Ltd. part number EHN38P-Ex.
- The radio shall only be used with optional adaptor identified as Hytera Communications Co., Ltd. part number POA203P-Ex.
- The radio may also be used with the optional leather cases, identified as Hytera Communications Co., Ltd. part number LCY028 or LCY029.
- The radio may be used with the optional belt clip adapter identified as Hytera Communications Co., Ltd. part number POA211.
- The radio shall only be used with antenna identified as Hytera Communications Co., Ltd. part numbers: AN0375H10, AN0375H11, AN0435H15, AN0435H16, AN0375H14, AN0375H15, AN0435H21, AN0435H22, AN0485H10, AN0485H11, AN0485H15, AN0485H16, AN0350H05, AN0350H06, AN0405H11, AN0405H12, AN0390H06, AN0390H07, AN0415H13, AN0415H14, AN0437H01, AN0437H02, AN0405H15, AN0405H16, AN0390H10, AN0390H11, AN0415H17, AN0415H18, AN0437H06 AN0437H07, AN0873H07, AN0873H08, AN0873H02, AN0873H03, AN0141H11, AN0141H12, AN0153H12, AN0153H13, AN0167H11, AN0167H12,

AN0141H09, AN0141H10, AN0153H10, AN0153H11, AN0167H09, AN0167H10, AN0155H08, AN0155H09, AN0155H17, AN0155H18, AN0390H08, AN0415H15, or AN0838H08.

1.4 Connection with Other Intrinsically Safe Equipment Specific Conditions of Use

When connecting the radio to other approved/certified equipment with energy limitation parameters, refer to the following connection block diagram and specific conditions of use.

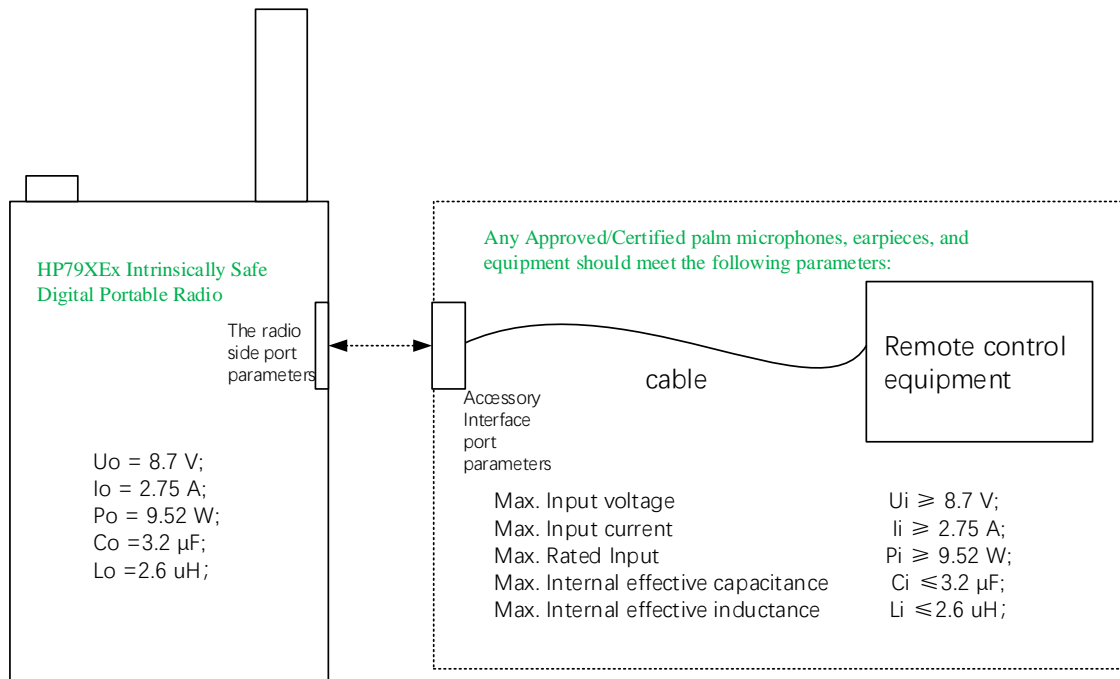

NOTE

- Connections to the radio side port shall only be made with an Approved or Certified Intrinsically Safe equipment having energy limitation parameters.
- The energy limitation parameters of the connected equipment shall have a $U_i \geq 8.7 \text{ V}$, $I_i \geq 2.75 \text{ A}$ and a $P_i \geq 9.52 \text{ W}$. The connecting cable capacitance plus the C_i shall not exceed $C_o = 3.2 \mu\text{F}$ and the connecting cable inductance plus the L_i shall not exceed $2.6 \mu\text{H}$.

1.5 Warnings

- Substitution of components may impair Intrinsic Safety.
- Use only Hytera BL2105-Ex battery.
- Do not charge the battery in hazardous location.
- Repaired only by Hytera or Hytera authorized Service Center.

- To prevent ignition of flammable or combustible atmospheres, read, understand and adhere to the manufacturer's live maintenance procedures unless there are no maintenance procedures.

1.6 Caution

- Do not charge the battery in hazardous location
- Do not detach, replace the battery or accessory in explosive dust atmosphere.
- Do not carry the radio into Zone 0 or Zone 20.
- Do not carry the battery alone to the hazardous atmosphere.
- Do not use the radio if its housing is damaged or cracked.
- Do not block or open the pressure adjustment hole on the radio.
- Do not use a damaged antenna. A minor burn may be caused when you touch a damaged antenna.
- Do not expose the radio to direct sunlight for a long time, nor place it close to a heating source.
- Do not attempt to disassemble, destroy, or short-circuit the battery. Never dispose of it in fire.
- Before using the radio in a hazardous atmosphere, ensure that the battery is installed on the radio tightly.
- If you wear the radio, ensure that its antenna is at least 2.5 centimeters away from your body during transmission.

1.7 No Misoperations

Stop operating the radio and leave the blasting area immediately when the intrinsic safety or integrity of the radio is endangered, and deliver it to your local dealer for examination.

The safety or reliability of the radio may be endangered when:

- The radio is stored improperly.
- The radio is faulty.
- The radio works with overload.
- The radio operates beyond the tolerance or threshold.
- The radio is damaged during transportation.
- The radio's housing is obviously damaged or cracked.
- The logo or characters on the radio are hard to be recognized.

1.8 Maintenance

Repaired only by Hytera or Hytera authorized Service Center.

Contact Person: Hytera Customer Service Center

Contact number: **Tel:** +86-755-2697299 **Fax:** +86-755-86137139

Contact Address:

Hytera Communications Corp., Ltd.

Hytera Tower, Hi-Tech Industrial Park North, 9108# Beihuan Road, NanshanDistrict, Shenzhen, P.R.C., P 518057

1.9 Training Instructions

Contact Person: Hytera Customer Training Center

Contact number: **Tel:** +86-755-2697299 **Fax:** +86-755-86137139

Contact Address:

Hytera Communications Corp., Ltd.

Hytera Tower, Hi-Tech Industrial Park North, 9108# Beihuan Road, NanshanDistrict, Shenzhen, P.R.C., P 518057

1.10 Hazardous Area Classification

Explosive Atmosphere

An explosive atmosphere refers to the mixture with air, under atmospheric conditions, of flammable substances in the form of gas, vapor, or dust, which, after ignition, permits self-sustaining flame propagation.

Explosion

An explosion is a rapid increase in volume and release of energy in an extreme manner, usually with the generation of high temperatures and the release of gases. There are three elements, which must be present to cause an explosion:

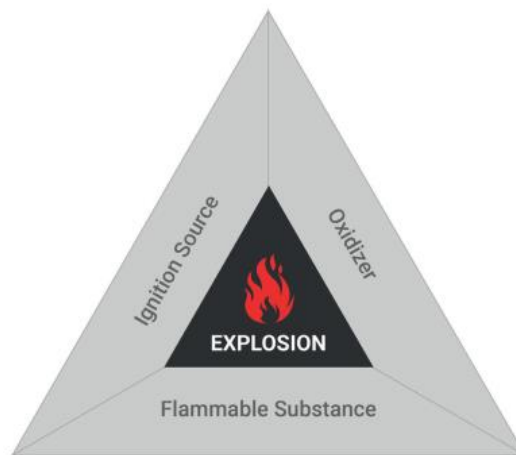

- Ignition Source
An element, which can cause a fire or explosion. Open flames, sparks, static electricity and hot surfaces are all possible ignition sources.
- Flammable substance
Substance, which is itself flammable, or is capable of producing a flammable gas, vapor, or dust.
- Oxidizer
A kind of chemical whereby fuel is required to burn. An oxidizer must be present in sufficient quantity in combination with the flammable substance to produce an explosive mixture. The most common oxidizer is air (O₂).

Intrinsically Safe

Intrinsic safety "i" is a protection approach to make equipment safe to be used in hazardous location, which is based on limiting electrical energy and thermal to a level below that required to ignite a specific explosive atmospheres mixture. In hazardous locations, specially designed equipment must be used to protect against the potentially explosive atmospheres. These devices, which can be used in the potentially explosive environments without causing an explosion, are called Intrinsically Safe devices.

Classification of Zones

According to the likelihood of a potentially explosive atmosphere, gas and dust atmosphere are categorized into three zones respectively:

Hazardous Substance	Present Continuously or for Long Periods or Frequently	Occur Periodically or Occasionally in Normal Operation	Not Likely to Occur in Normal Operation
Gas	Zone 0	Zone 1	Zone 2

Hazardous Substance	Present Continuously or for Long Periods or Frequently	Occur Periodically or Occasionally in Normal Operation	Not Likely to Occur in Normal Operation
Dust	Zone 20	Zone 21	Zone 22

- **Zone 0:** An area in which an explosive gas atmosphere is present **continuously** or for **long periods** or **frequently**.
- **Zone 1:** An area in which an explosive gas atmosphere is likely to **occur periodically** or **occasionally** in normal operation.
- **Zone 2:** An area in which an explosive gas atmosphere is **not likely to occur** in normal operation, but if it does occur, it will exist for a short period only.
- **Zone 20:** A place in which an explosive dust atmosphere, in the form of a cloud of dust in air, is present **continuously**, or for **long periods** or **frequently**.
- **Zone 21:** A place in which an explosive dust atmosphere, in the form of a cloud of dust in air, is **likely to occur** in normal operation occasionally.
- **Zone 22:** Area in which an explosive dust atmosphere, in the form of a cloud of combustible dust in air, is **not likely to occur** in normal operation but, if it does occur, will persist for a short period only.

Classification of Equipment Groups

According to the ignition characteristics, flammable gases and dusts are categorized into the following groups:

Group		Representative Materials
Group I (Mines)	/	Methane
Group II (Gas)	IIA	Propane
	IIB	Ethylene
	IIC	Acetylene and hydrogen
Group III (Dust)	IIIA	Fibers and flyings
	IIIB	Non-conductive dusts
	IIIC	Metal dusts

Classification of Surface Temperature

According to the maximum temperature that may appear on the surface of equipment, the maximum surface temperature is categorized into six classes.

Temperature Class	Maximum Surface Temperature
T1	$\leq 450\text{ }^{\circ}\text{C}$
T2	$\leq 300\text{ }^{\circ}\text{C}$
T3	$\leq 200\text{ }^{\circ}\text{C}$
T4	$\leq 135\text{ }^{\circ}\text{C}$
T5	$\leq 100\text{ }^{\circ}\text{C}$
T6	$\leq 85\text{ }^{\circ}\text{C}$

2. Packing List

Please unpack carefully and check that you have received the following items. If any item is missing or damaged, contact your dealer.

Item	Quantity (PCS)	Item	Quantity (PCS)
Radio	1	Antenna	1
Battery	1	Belt Clip	1
Charger	1	Strap	1
Power Adapter	1	Documentation Kit	1

NOTE

- Figures in this manual are only for reference.
 - Check whether the frequency band marked on the antenna label matches that on the radio label. If not, contact your dealer.
-

3. Product Overview

3.1 Product Layout

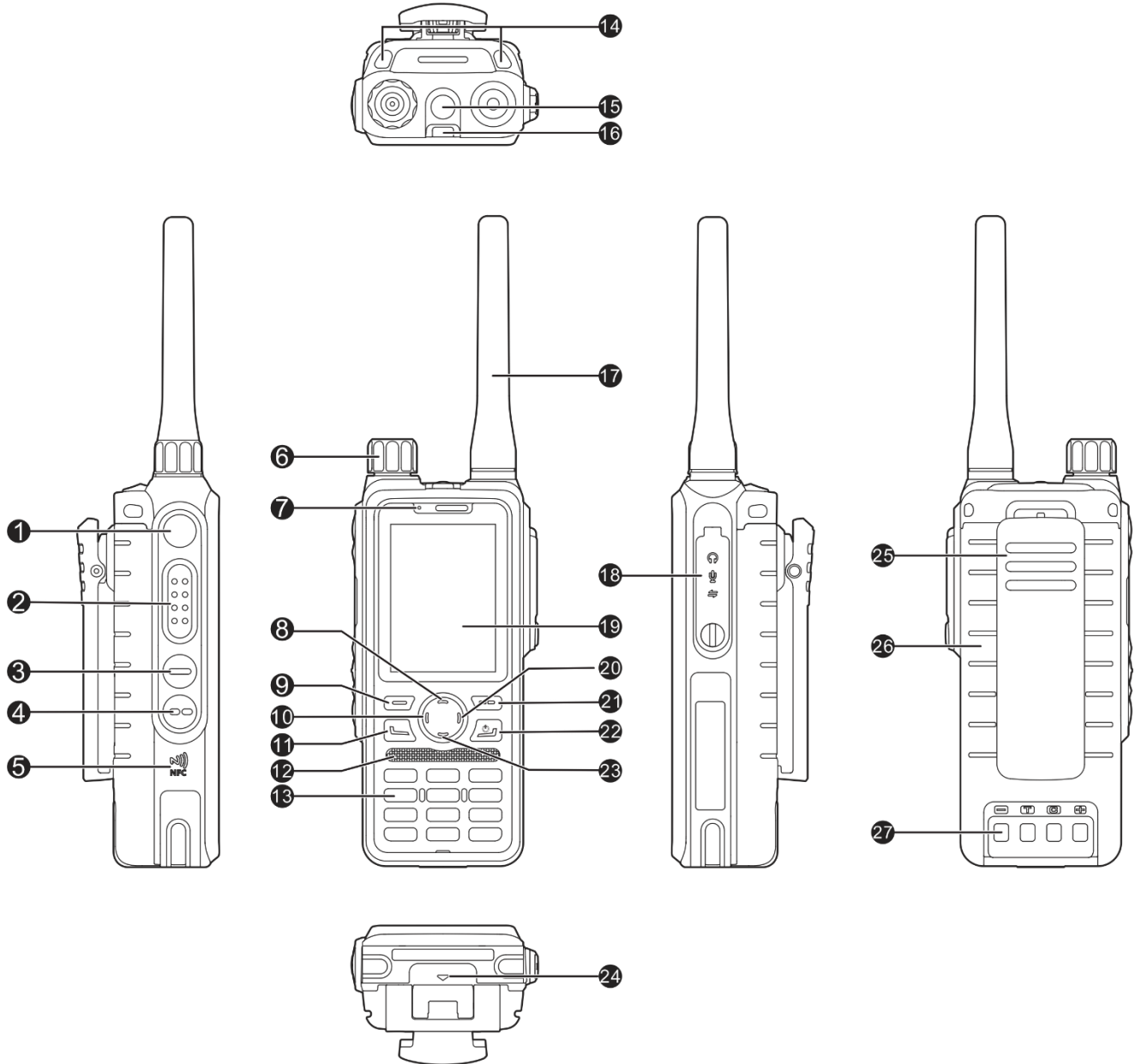

No.	Part Name	No.	Part Name	No.	Part Name
1	Side Key 1 (SK1)	10	Left Key	19	LCD Display
2	Push-to-Talk (PTT) Key	11	P1/Answer Key	20	Right Key
3	Side Key 2 (SK2)	12	Speaker	21	Back/Subgroup Key
4	Side Key 3 (SK3)	13	Keypad	22	On-Off/P2/End Key
5	NFC Tag	14	Strap Hole	23	Down Key

No.	Part Name	No.	Part Name	No.	Part Name
6	Smart Knob	15	Top Key (TK)	24	Battery Latch
7	Microphone	16	LED Indicator	25	Belt Clip
8	Up Key	17	Antenna	26	Battery
9	OK/Menu Key	18	Accessory Connector	27	Charging Contacts

3.2 Programmable Keys

For enhanced convenience, you can request your dealer to program the following keys as shortcuts to radio features: **TK**, **SK1**, **SK2**, **SK3**, **P1/Answer** key, **On-Off/P2/End** key, **Up** key, and **Down** key. For details, consult your dealer.

4. Before Use

4.1 Attach the Battery

CAUTION

- Make sure the grooves on the battery are aligned with the guiderails on the sides of battery compartment, otherwise the guiderails may deform.
- Use the approved battery to avoid the risk of explosion.
- Dispose of the used battery according to "Precautions for Disposal" in the *Safety Information Booklet*.

1. Align the grooves ① on the battery with the guiderails ② on the sides of the battery compartment.

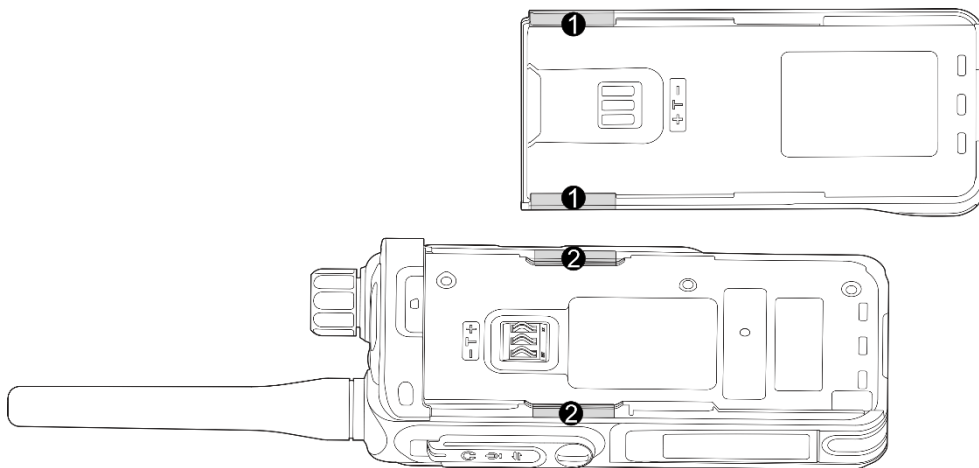

2. Lift and hold the battery latch ③, and then slide the battery into the battery compartment ④ until you hear a click.

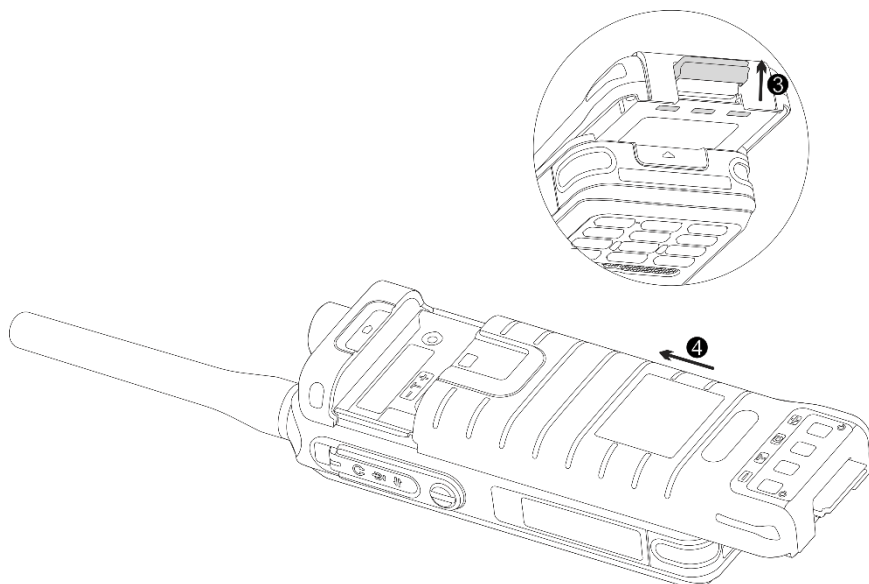

3. Release the battery latch.

 **NOTE**

To remove the battery, make sure that the radio is turned off, and then lift the battery latch.

4.2 Charge the Battery

 **CAUTION**

- Use the charger CH10L33 approved by the Company.
- Read the *Safety Information Booklet* before charging.
- The remaining lithium-ion battery power is limited to 30% pursuant to the new lithium battery shipment regulation approved by the International Air Transport Association (IATA).
- It is recommended that the radio remains turned off during charging.

Before initial use, charge either the battery alone or the battery that is attached to the radio.

You can learn about the charging status through the LED indicator on the charger.

LED Indicator	Charging Status
Glows red	The battery is being charged.
Glows green	The battery is fully charged.
Flashes red slowly	No battery is inserted to the charger.
Flashes red rapidly	The battery fails to be charged.

4.3 Attach the Antenna

 **CAUTION**

Do not hold the radio by the antenna and swing it. This may affect the antenna performance and shorten the life span of the antenna.

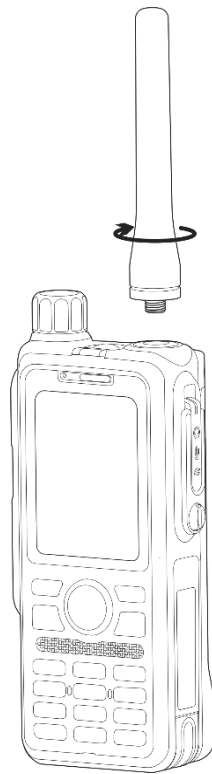

4.4 Attach the Audio Accessory

CAUTION

For optimal waterproof and dustproof performance, do as follows:

- Attach the accessory with care to avoid scraping the silicone rubber surrounding the accessory connector screw hole.
 - Close the accessory connector cover and fasten the screw after removing the accessory.
-

1. Loosen the screw on the accessory connector cover, and then remove the cover.

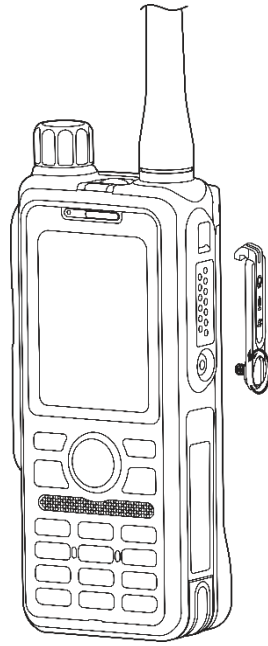

2. Insert the audio accessory plug into the accessory connector.
3. Tighten the screw on the audio accessory plug.

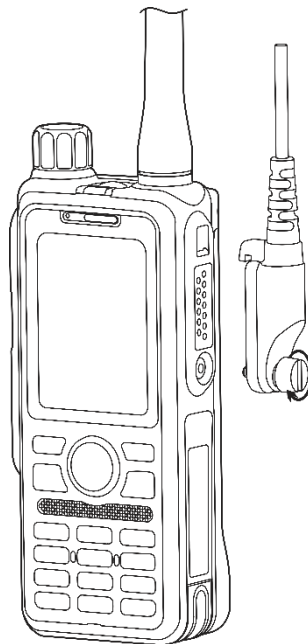

4.5 Attach the Belt Clip

Align the holder on the belt clip with the groove on the battery, and then press the belt clip downwards into place.

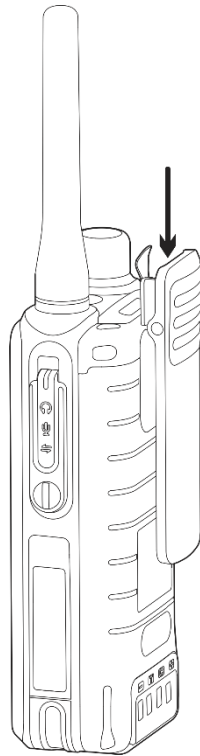

NOTE

You can press and hold the spring plate of the belt clip and push the belt clip upwards to remove it.

4.6 Install the TF Card

If you purchase a TF card, you can install it on the radio.

1. Use a screwdriver to loosen the screw on the card slot cover, and then remove the card slot cover.

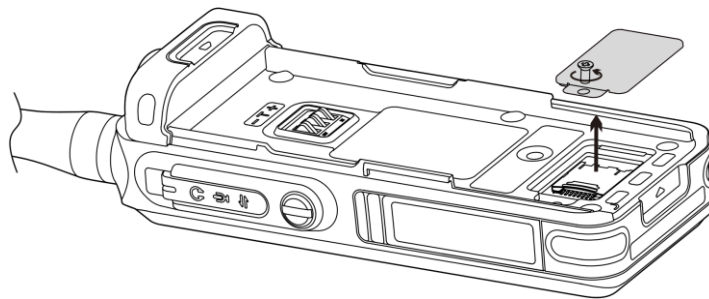

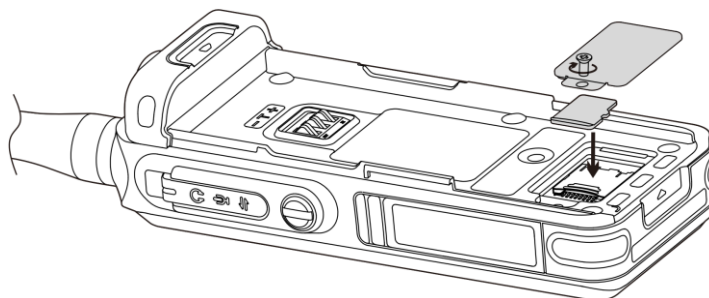

2. Install the TF card, put the card slot cover back in place, and then tighten the screw.



5. Basic Operations

5.1 Turn On or Off the Radio

- To turn the radio on, long press  or reattach the battery.
- To turn the radio off, long press .

5.2 Adjust the Volume

Rotate the **Smart Knob** clockwise to increase the volume, or counter-clockwise to decrease the volume.

5.3 Select Contact or Channel



On the home screen, press and rotate the **Smart Knob** within 5s to select a contact or channel.

NOTE



If you do not select contact or channel, or press the **Smart Knob** again within 5s, the **Smart Knob** automatically switches to volume control mode.

5.4 Lock or Unlock the Keypad

When the keypad is not in use, it is recommended that you lock it to avoid unintended operations.

- Auto Lock
 - a. Go to **Menu > Settings > Basic Settings > Keypad Lock**.
 - b. Press  to turn on **AutoLock**.
 - c. Select **Timed**, set the auto lock time, and then press .

If you do not operate the radio or if the radio receives no call or message within the auto lock time, the keypad is locked automatically.

- Manual Lock or Unlock
 - Press the preprogrammed **Keypad Lock** key.
 - On the home screen, press , and then press .

- Keypad Lock Backup



With this feature preprogrammed by your dealer, the radio automatically saves the last settings of keypad lock upon power-off.

 **NOTE**

You can go to **Menu > Settings > Basic Settings > Keypad Lock > Optional Key** to set whether the following keys and knobs still work when the keypad is locked: **TK, SK1, SK2, SK3, PTT key, P1/Answer key, On-Off/P2/End key, and Smart Knob.**

5.5 Understand Keypad Operations

You can use the keypad to enter contact aliases and IDs, or edit messages.

- To switch the input method between alphabetic mode and numeric mode, press .
- To enter special characters, press  in alphabetic mode.
- To enter a space, press  in alphabetic mode.

5.6 Switch the Operation Mode

The radio can operate in conventional mode, or digital trunking mode (preprogrammed by your dealer).

- Manual Switch
 - On the home screen, go to **Menu > Mode**, and then select the mode.
 - Press the preprogrammed **Operation Mode Switch** key.
 - If the Zone/Subgroup Switch Mode feature is enabled, you can switch the operation mode by switching the contact through the menu or the **Smart Knob**.
- Auto Switch

The Mode Auto Switch feature allows the radio to automatically switch the operation mode, so as to ensure smooth communication in case of the radios in blind spot or the system failure.

To turn on this feature, go to **Menu > Mode > Auto Switch**, or press the preprogrammed **Mode Auto Switch** key.

5.6.1 Conventional Mode

In conventional mode, a zone is a group of channels within the same operational area. The radio receives and transmits data and voice on the selected channel.

Select a Zone

To select a zone, do either of the following:

- On the home screen, go to **Menu > Zone**, select the zone, and then select **Set Default**.

- Press the preprogrammed **Zone Up** or **Zone Down** key.

Select a Channel

Before selecting a channel, make sure that the current zone contains the channel.

To select a channel, do one of the following:

- On the home screen, press and rotate the **Smart Knob** within 5s to select a channel.
- On the home screen, go to **Menu > Zone**, select the zone, and then select the channel.
- Press the preprogrammed **Channel Up** or **Channel Down** key.
- Press the preprogrammed **Preset Channel** key.

NOTE

If the Voice Notify feature is enabled, the radio automatically announces the current channel upon power-on and channel change.

5.6.2 Trunking Mode

In trunking mode, the radio automatically hunts for available base stations (BS). During hunting, the LCD displays "Hunting...". After registration, the radio can receive and transmit voice and data.

Select a Group or Private Contact

To select a group contact or a private contact, do one of the following:

- On the home screen, press and rotate the **Smart Knob** within 5s to select a group or private contact.
- On the home screen, press  or go to **Menu > Subgroup**, select the subgroup, and then select the group or private contact.
- Press the preprogrammed **Group/Private Up** or **Group/Private Down** key.

Select a Subgroup





















A subgroup consists of multiple groups or private contacts.





















To select a subgroup, do either of the following:

- On the home screen, press  or go to **Menu > Subgroup**, select the subgroup, and then select **Set Default**.
- Press the preprogrammed **Subgroup Up** or **Subgroup Down** key.

6. Status Indications

6.1 LCD Icons

Icon	Radio Status
	More bars indicate more remaining battery power.
	The battery power is running out.
	The battery power runs out.
	<ul style="list-style-type: none"> Conventional mode: The radio is standby or transmitting. Trunking mode: The radio is not registered with the base station.
	More bars indicate stronger signal.
	The radio works in low power mode.
	The radio works in high power mode.
	The keypad is locked.
	An accessory is connected.
	The GPS feature is enabled, and valid positioning data has been received.
	The GPS feature is enabled, but no valid positioning data has been received.
	The BT feature is enabled.
	A BT device is connected.
	The radio is in emergency mode.
	The radio stays on a site.
	The radio is roaming.
	The Scrambler or Encryption feature is enabled.
	The Over the Air Encryption feature is enabled.
	The Mode Auto Switch feature is enabled.
	The radio is scanning or hunting.
	The radio stays on an active channel.

Icon	Radio Status
	The radio stays on Priority Channel 1.
	The radio stays on Priority Channel 2.
	The radio has switched to the mixed channel.
	The Non-Dedicated Trunk Station Control Channel (TSCC) feature is enabled.
	The TF card is abnormal.
	The TF card is about full.
	The TF card is full.
	The radio is recording the call.
	An error occurs during call recording.
	The VOX feature is enabled.
	The Monitor feature is enabled.
	The speaker is unmuted.
	The radio operates in silent mode.
	The radio operates in profile 1.
	The radio operates in profile 2.
	The radio operates in profile 3.
	The radio operates in covert mode.
	There is/are new/unread message(s).
	The inbox is full.
	There is/are missed call(s).
	The Call Divert feature is enabled.

6.2 LED Indicator

LED Indicator	Radio Status
Flashes green	The radio is being turned on.

LED Indicator	Radio Status
Flashes green slowly	The radio is standby in trunking mode.
Glowes green	The radio is receiving.
Glowes red	The radio is transmitting.
Flashes red	The radio is establishing a call in trunking mode. (This indication is applicable only to the calling radio.)
Flashes orange slowly	<ul style="list-style-type: none"> ● Conventional mode: The radio is scanning or roaming. ● Trunking mode: The radio is hunting.
Flashes orange rapidly	<ul style="list-style-type: none"> ● Conventional mode: The radio is operating in emergency mode. ● Trunking mode: The radio is establishing a Full Off Air Call Set-up (FOACSU) private call. (This indication is applicable only to the called radio.)
Glowes orange	The radio is within call hang time. Within such a period, you can press and hold the PTT key to call back.
Flashes blue every 3s	The BT feature is enabled, but no BT device is connected.
Flashes blue every 1.5s	A BT device is connected.
Flashes blue every 0.1s	The BT feature is being disabled.

7. Call Services

When you are speaking during a call, keep the microphone about 2.5 cm to 5 cm away from your mouth. This ensures optimal voice quality on the receiving radio.

NOTE

In trunking mode, if the radio is not registered or attached, or an empty group is selected, you will fail to initiate a call.

7.1 Group Call

A group call is a call from an individual user in a group to all the other members in the group.

NOTE



In trunking mode, with the Auto Select Available Site feature preprogrammed by your dealer, the radio automatically registers with an unrestricted BS for successful call establishment when making a call to the restricted group.

7.1.1 Initiate a Group Call

Through Preset Contact



Press and rotate the **Smart Knob** to select the digital channel or group contact, and then press and hold the **PTT** key.

Through Contact List

- Conventional Mode
 - a. Press the preprogrammed **Contact List** or **Favorite Contact List** key, or go to **Menu > Contact > Contact/Favorite**.
 - b. Select the group contact.
 - c. Press and hold the **PTT** key.
- Trunking Mode
 - Press  or the preprogrammed **Current Subgroup Contact** key, select the subgroup and group contact, and then press  or the **PTT** key.
 - Press the preprogrammed **Favorite Contact List** key, or go to **Menu > Contact > Favorite**, select the group contact, and then press  or the **PTT** key.

Through Manual Dialing

- Conventional Mode



- With the group call dial permission preprogrammed by your dealer, on the home screen, enter the group ID, select **Group ID**, and then press and hold the **PTT** key.
- With the Keypad Mode feature preprogrammed by your dealer, go to **Menu > Settings > Basic Settings > Keypad Mode**, and then select **On**. On the home screen, enter the group ID, select **Group ID**, and then press and hold the **PTT** key.
- **Trunking Mode:** On the home screen, enter the group ID, select **Group ID**, and then press , , or the **PTT** key.

NOTE

The group ID must comply with the dialing rules. For details, consult your dealer.

Through Call Logs

In trunking mode, you can initiate a group call through the call logs.

- On the home screen, go to **Menu > Call Logs**, select the group call record, and then press  or the **PTT** key.
- Press the preprogrammed **BackDial Call** or **ReDial Call** key, select the group call record, and then press  or the **PTT** key.

Through One Touch Call/Menu

With the One Touch Call/Menu feature preprogrammed by your dealer, do as follows:

- In conventional mode, press the preprogrammed **One Touch Call/Menu** key, and then press and hold the **PTT** key.
- In trunking mode, press the preprogrammed **One Touch Call/Menu** key.

7.1.2 Answer a Group Call

You can answer a group call without any operation.

7.1.3 End a Group Call

Conventional Mode

In conventional mode, a group call ends when the call hang time expires.

Trunking Mode

In trunking mode, a group call ends in any of the following cases:

- The call hang time expires.

- The calling party hangs up.
- The call duration exceeds the preset time.
- The BS signal is lost.
- A pre-emptive call or an emergency call occupies the channel.
- With the Clear Down feature enabled, the calling party changes the contact.

7.2 Private Call



A private call is a call from an individual user to another individual user.

7.2.1 Initiate a Private Call



Through Preset Contact

Press and then rotate the **Smart Knob** to select the digital channel or private contact, and then press and hold the **PTT** key.

Through Contact List

- Conventional Mode
 - a. Press the preprogrammed **Contact List** or **Favorite Contact List** key, or go to **Menu > Contact/Favorite**.
 - b. Select the private contact.
 - c. Press and hold the **PTT** key.
- Trunking Mode
 - Press  or the preprogrammed **Current Subgroup Contact** key, select the private contact, and then press  or the **PTT** key.
 - Press the preprogrammed **Contact List** key, or go to **Menu > Contact > Favorite/Private**, select the private contact, and then press  or the **PTT** key.



Through Manual Dialing

- Conventional Mode
 - With the private call dial permission preprogrammed by your dealer, on the home screen, enter the private ID, select **Private ID**, and then press and hold the **PTT** key.
 - With the Keypad Mode feature preprogrammed by your dealer, go to **Menu > Settings > Basic Settings > Keypad Mode**, and then select **On**. On the home screen, enter the private ID, select **Private ID**, and then press and hold the **PTT** key.
- Trunking Mode: On the home screen, enter the private ID, and then press , , or the **PTT** key.

 **NOTE**

The private ID must comply with the dialing rules. For details, consult your dealer.

Through Call Logs

- Conventional Mode: Go to **Menu > Call Logs**, select the private call record, and then press and hold the **PTT** key.
- Trunking Mode
 - On the home screen, go to **Menu > Call Logs**, select the private call record, and then press  or the **PTT** key.
 - Press the preprogrammed **BackDial Call** or **ReDial Call** key, select the private call record, and then press  or the **PTT** key.

Through One Touch Call/Menu

With the One Touch Call/Menu feature preprogrammed by your dealer, do as follows:

- In conventional mode, press the preprogrammed **One Touch Call/Menu** key, and then press and hold the **PTT** key.
- In trunking mode, press the preprogrammed **One Touch Call/Menu** key.

7.2.2 Answer a Private Call

Conventional Mode

You can answer a private call without any operation.

Trunking Mode

The operations vary with the answer mode of the private call.

- FOACSU
When receiving a FOACSU private call, the radio rings and vibrates. To answer the call, press the **PTT** key within the preset time.
- Off Air Call Set-Up (OACSU)
The call is established automatically.

7.2.3 End a Private Call

Conventional Mode

In conventional mode, a private call ends when the call hang time expires.

Trunking Mode

In trunking mode, a private call ends in any of the following cases:

- The call hang time expires.
- The calling or called party hangs up.
- The call duration exceeds the preset time.
- The BS signal is lost.
- A pre-emptive call or an emergency call occupies the channel.
- With the Clear Down feature enabled, the calling or called party changes the contact.

7.3 All Call

- Conventional Mode

In conventional mode, an all call is a call from an individual user to all the other users on the current digital channel.

- Trunking Mode

In trunking mode, an all call is a call from an individual user to all the other users in the network.

An all call has the following types:

- Broadcast All Call: Only the calling party can transmit voice.
- General All Call: Both the calling party and the called party can transmit voice.

To select the all call type, go to **Menu > Settings > Call Settings > All Call**, and then select **Broadcast Call** or **General Call**.

NOTE

The All Call feature is preprogrammed by your dealer.

7.3.1 Initiate an All Call

Through Preset Contact

In conventional mode, press and then rotate the **Smart Knob** to select the all call contact preset for the digital channel, and then press and hold the **PTT** key.



Through Contact List

In conventional mode, do as follows:

1. Press the preprogrammed **Contact List** or **Favorite Contact List** key, or go to **Menu > Contact > Contact/Favorite**.

2. Select the all call contact.
3. Press and hold the **PTT** key.

Through Manual Dialing

In trunking mode, on the home screen, enter the all call ID, and then press , , or the **PTT** key.

NOTE

The all call ID must comply with the dialing rules. For details, consult your dealer.

Through Call Logs

In trunking mode, press the preprogrammed **BackDial Call** or **ReDial Call** key, select the all call record, and then press  or the **PTT** key.

Through One Touch Call/Menu

With the One Touch Call/Menu feature preprogrammed by your dealer, do as follows:

- In conventional mode, press the preprogrammed **One Touch Call/Menu** key, and then press and hold the **PTT** key.
- In trunking mode, press the preprogrammed **One Touch Call/Menu** key.

7.3.2 Answer an All Call

You can answer an all call without any operation.

7.3.3 End an All Call

Conventional Mode

An all call ends when the calling party releases the **PTT** key.

Trunking Mode

In trunking mode, an all call ends in any of the following cases:

- The calling party releases the **PTT** key.
- The calling party hangs up.
- The call duration exceeds the preset time.
- The BS signal is lost.
- With the Clear Down feature enabled, the calling party changes the contact.

7.4 Broadcast Call (Trunking Only)



A broadcast call is a special group call, during which only the calling party can transmit voice.

NOTE



The Broadcast Call feature is preprogrammed by your dealer.

7.4.1 Initiate a Broadcast Call

Through Contact List

- Subgroup Contact List
 - a. Press  or the preprogrammed **Current Subgroup Contact** key.
 - b. Select the subgroup and group contact.
 - c. Set the call type to **Broadcast Call**.
 - d. Press  or the **PTT** key.
- Favorite Contact List
 - a. Press the preprogrammed **Favorite Contact List** key, or go to **Menu > Contact > Favorite**.
 - b. Select the group contact.
 - c. Set the call type to **Broadcast Call**.
 - d. Press  or the **PTT** key.



Through Manual Dialing

On the home screen, enter the broadcast call ID, and then press , , or the **PTT** key.

NOTE

The broadcast call ID must comply with the dialing rules. For details, consult your dealer.

Through Call Logs

- Go to **Menu > Call Logs**, select the group call record, set the call type to **Broadcast Call**, and then press  or the **PTT** key.
- Press the preprogrammed **BackDial Call** or **ReDial Call** key, select the group call record, set the call type to **Broadcast Call**, and then press  or the **PTT** key.

Through One Touch Call/Menu

With the One Touch Call/Menu feature preprogrammed by your dealer, press the preprogrammed **One Touch Call/Menu** key.

7.4.2 Answer a Broadcast Call

You can answer a broadcast call without any operation.

7.4.3 End a Broadcast Call

A broadcast call ends in any of the following cases:

- The call duration exceeds the preset time.
- The calling party hangs up.
- The BS signal is lost.
- A pre-emptive call or an emergency call occupies the channel.
- With the Clear Down feature enabled, the calling party changes the contact.

7.5 Include Call (Trunking Only)

An include call is a special group call during which another group is invited during the call hang time. An include call has the same Talk Priority and Clear Down feature as a group call.

 **NOTE**

The Include Call feature is preprogrammed by your dealer.

For operations of initiating, answering, or ending an include call, see [7.1 Group Call](#).

7.6 Phone Call

A phone call is a call between a radio and a phone. After a repeater accesses the PSTN/PABX system through a PSTN/PABX gateway, the radio can communicate with the phone through the repeater.



7.6.1 Initiate a Phone Call

Through Contact List

- Conventional Mode
 - a. Press the preprogrammed **Contact List** or **Favorite Contact List** key, or go to **Menu > Contact/Favorite**.
 - b. Select the phone contact.
 - c. Press and hold the **PTT** key.
- Trunking Mode
 - a. Press the preprogrammed **Favorite Contact List** key, or go to **Menu > Favorite/Private**.
 - b. Select the PSTN/PABX contact.

- c. Press  or the **PTT** key.

Through Manual Dialing



- Conventional Mode: With the phone call dial permission preprogrammed by your dealer, on the home screen, enter the phone number, select **DTMF Dial**, and then press and hold the **PTT** key.
- Trunking Mode: On the home screen, enter the phone number, select **PSTN** or **PABX** (press  to switch), and then press , , or the **PTT** key.

NOTE

The phone number must comply with the dialing rules. For details, consult your dealer.

Through Call Logs

In trunking mode, you can initiate a phone call through the call logs.

- Go to **Menu > Call Logs**, select the PSTN/PABX call record, and then press  or the **PTT** key.
- Press the preprogrammed **BackDial Call** or **ReDial Call** key, select the PSTN/PABX call record, and then press  or the **PTT** key.

Through One Touch Call/Menu

With the One Touch Call/Menu feature preprogrammed by your dealer, press the preprogrammed **One Touch Call/Menu** key.

7.6.2 Answer a Phone Call

Conventional Mode

When receiving a phone call, press  key (with the One-Key Connect feature enabled) or enter the connect code to join the phone system. Then you can answer the phone call.

Trunking Mode

When receiving a phone call, press  or the **PTT** key to answer the call.

7.6.3 End a Phone Call

Conventional Mode

In conventional mode, a phone call ends in either of the following cases:

- The calling party hangs up.
- The called party presses  (with the One-Key Disconnect feature enabled) or enters the disconnect code.

Trunking Mode

In trunking mode, a phone call ends in any of the following cases:

- The call duration exceeds the preset time.
- The calling party hangs up.
- The BS signal is lost.
- A pre-emptive call or an emergency call occupies the channel.
- With the Clear Down feature enabled, the calling party changes the contact.

7.7 Call on Analog Channel

In conventional mode, you can initiate or receive a call on an analog channel with or without signaling.

7.7.1 Call Without Signaling

On an analog channel without signaling, you can initiate a call to all the other users on the channel.

On the home screen, press and then rotate the **Smart Knob** to select the channel, and then press and hold the **PTT** key.

7.7.2 Call with Signaling

On an analog channel with signaling, you can initiate a call to a specific contact on the channel.

1. On the home screen, go to **Menu > Contact**, or press the preprogrammed **Contact List** key.
2. Select the contact.
3. Press and hold the **PTT** key or the preprogrammed **One Touch Call/Menu** key.



8. Message Services

The radio can send and receive short messages, which are classified into the following types:

- Text message: a message containing text or numbers
- Quick text message: a frequently used text message that can be created, edited, or deleted through the menu
- Status message: a predefined code that transfers the message content

8.1 Send a Message

8.1.1 Through Message

1. On the home screen, go to **Menu > Message > Msg New > New Msg.**
2. Select the contact in either of the following ways:
 - In the recipient text box, enter the contact ID, and then press  to switch the ID type.
 - Press  to enter the contact list, and then select the contact.
3. Do either of the following:
 - To send a text message, enter the message content in the message text box.
 - To send a quick text message or status message (trunking only), select **Insert** to add the message.
4. Press  to send the message.

8.1.2 Through Contact

- Conventional Mode
 - a. On the home screen, go to **Menu > Contact > Contact/Favorite.**
 - b. Select the contact.
 - c. Select **New Msg.**
 - d. Enter the message content.
 - e. Press  to send the message.
- Trunking Mode
 - a. On the home screen, go to **Menu > Contact > Favorite/Private.**
 - b. Select the contact.
 - c. Select **New Msg.**
 - d. Enter the message content.
 - e. Press  to send the message.

8.2 Reply to a Message

To reply to a message, do as follows:

1. On the home screen, go to **Menu > Message > Msg**.
2. Select a conversation.
3. Select **Reply**.
4. Do either of the following:
 - To send a text message, enter the message content in the message text box.
 - To send a quick text message or status message (trunking only), select **Insert** to add the message.
5. Press  to send the message.

8.3 Edit a Message

To edit a message, do as follows:

1. On the home screen, go to **Menu > Message > Msg**.
2. Select a dialog box.
3. Press the **Up** key, and then press the **OK/Menu** key.
4. Do one of the following:
 - Select **Forward** to forward the message.
 - Select **Delete** to delete the message.
 - Select **Delete All** to delete all messages with the contact.

9. Supplementary Features

9.1 Settings

On the home screen, go to **Menu > Settings**, and then set radio parameters including **Basic Settings**, **Call Settings**, and **Security Settings**.

9.1.1 Basic Settings

Language

Go to **Basic Settings > Language**, and then select the display language.

Display

Go to **Basic Settings > Display**, and then set any of the following:

- Backlight

The backlight is designed to illuminate the display and keypad.

Select **Backlight**, and then select **Off**, **Light**, or **Timed**.

- Night Mode

The display modes include day mode and night mode. The screen brightness and user interface vary with the display mode.

Select **Night Mode** to switch between the two modes.

- Brightness

Select **Brightness**, and then select the screen brightness level.

Smaller number indicates higher level of brightness.

Keypad Lock

For details, see [5.4 Lock or Unlock the Keypad](#).

Date and Time

The radio displays the local time by default. If no time data is received, the radio displays "--:--".

Go to **Basic Settings > Date & Time**, and then do any of the following:

- With the Time Display feature preprogrammed by your dealer, select **Time Display** to enable or disable the display of time on the home screen, or in the call logs and message interface.

- With the Time View feature preprogrammed by your dealer, select **Time View** to view the current **Time**, **Date**, and **Week**.
- Select **Time Set**, and then modify the **H/M/S/Y/M/D** to be displayed.
- Select **Time Format**, and then set the format to **24 Hour** or **12 Hour**.
- Select **Time Zone**, and then set the time zone.

Keypad Mode

With the Keypad Mode feature preprogrammed by your dealer, go to **Basic Settings > Keypad Mode**, and then do any of the following:

- Select **On** to turn on the manual dialing on the home screen.
- Select **Off** to turn off the manual dialing on the home screen.
- Select **One Touch Call/Menu** to trigger the One Touch Call/Menu feature by the numeric keypad.

Microphone and Speaker

The MIC & SPK feature allows you to select the microphone and speaker used by the radio for transmitting and receiving voice. With the audio accessory connected, you can switch the audio options. For details, see the following table.

Option	Description	Operation
Follow PTT	When you transmit voice through the PTT key of the radio, the radio uses the internal microphone. When you transmit voice through the audio accessory, the radio uses the external microphone.	<ul style="list-style-type: none"> ● Through the menu <ol style="list-style-type: none"> Go to Basic Settings > MIC & SPK. Select MIC Selection or SPK Selection. Select the audio option. ● Press the preprogrammed Mic Set Switch or SPK Set Switch key to switch the audio option.
Only Internal	The radio uses only the internal microphone and speaker.	
Only External	The radio uses only the microphone and speaker of the audio accessory, such as earpieces and remote speaker microphone.	
External First	When audio accessories are connected, the radio uses the external microphone and speaker. Otherwise, the radio uses the internal microphone and speaker.	

9.1.2 Call Settings

Power Level

You can set the TX power level to high or low.

On the home screen, go to **Call Settings > Power Level**, and then select **High Power** or **Low Power**.

VOX

Voice Activated Transmit (VOX) allows the voice to trigger transmission. When the voice detected by the microphone reaches the value to trigger the transmission, the radio automatically transmits the voice without the **PTT** key pressed.

To turn on or off VOX, do either of the following:

- On the home screen, go to **Call Settings > VOX**, and then select **On/Off**.
- Press the preprogrammed **VOX** key.

In the VOX interface, you can also select **External** or **Internal** to adjust sensitivity. Higher level indicates lower sensitivity.

Talker Alias

With the Talker Alias feature preprogrammed by your dealer, you can do either of the following:

- Sending the Caller Alias

On the home screen, go to **Call Settings > Talking Alias**, and then turn on or off **Send Alias**.

With the Send Alias feature enabled, you can send the radio alias when initiating a call. The called party can view the alias on the display and identify the calling party.

- Adding a Contact Automatically

On the home screen, go to **Call Settings > Talking Alias**, and then turn on or off **Auto Add Contact**.

When the radio receives a call from unknown calling party with the Send Alias feature enabled, the radio will automatically save this number to the **Contact** list.

In conventional mode, this feature is preprogrammed by your dealer. In trunking mode, you can select **Auto Add Contact**, and then turn on or off the feature.

Talk Around (Conventional Only)

The Talk Around feature allows you to continue communication in direct mode when the repeater malfunctions or the radio is out of the coverage of the repeater.

On the home screen, go to **Call Settings > Talk Around**, and then turn on or off the feature.

Squelch Level (Conventional Only)

The squelch level refers to the squelch threshold required for the speaker of the radio to be turned on. The higher squelch level requires a stronger signal.

- On the home screen, go to **Call Settings > Squelch**, and then select **Open, Normal, or Tight**.
- Press the preprogrammed **Adjust Squelch Level** key to adjust the level.

Compandor (Conventional Only)

The Compandor feature allows the radio to compress the voice signal when transmitting and decompress the audio when receiving to improve the audio quality.

On the home screen, go to **Call Settings > Compandor**, and then turn on or off the feature.

ESN Check in Idle (Trunking Only)

The ESN Check in Idle feature allows the radio to respond to the ESN check from the trunking system when the radio is registering or after the radio has registered.

On the home screen, go to **Call Settings > ESN Check In Idle**, and then turn on or off the feature.

- With ESN Check in Idle enabled, the radio responds to the ESN check during registration and after registration.
- With ESN Check in Idle disabled, the radio responds only to the ESN check during registration.

Call Priority (Trunking Only)

The Call Priority feature allows you to set the priority of all voice services except emergency calls. The priority levels include **Low, Medium, High, and Preemption** (with the Preemptive Call feature preprogrammed by your dealer).

When all channels are occupied, the call requests are put in a queue according to their priorities. When a channel is released, the call with a higher priority will be connected prior to the call with a lower priority.

- During group call queuing, only the calling party receives the queuing prompt.
- During private call queuing, both the calling party and the called party receive queuing prompt.

When the queue is full, the higher-priority calls can jump the queue, and the lower-priority calls will be extruded out (the system will prompt that it is busy) accordingly.

On the home screen, go to **Call Settings > Priority**, and then select the priority level.

Any Call (Trunking Only)

The Any Call feature allows the radio to initiate a call to a contact whose ID is not in the contact list.

- On the home screen, go to **Call Settings > Any Call**, and then turn on or off **Private ID**.

With Private ID enabled, you can call any private contacts.

With Private ID disabled, you can call only the private contacts in the contact list or emergency contact.

- On the home screen, go to **Call Settings > Any Call**, and then turn on or off **Group ID**.

With Group ID enabled, you can call any group contacts except that of the background group.

With Group ID disabled, you can call only the group contacts in the contact list, dynamic group, or emergency contact.

- On the home screen, go to **Call Settings > Any Call**, and then turn on or off **Phone**.

With Phone enabled, you can call any PABX/PSTN contacts.

With Phone disabled, you can call only the PABX/PSTN contacts in the contact list or emergency contact.

Call Divert (Trunking Only)

When the radio malfunctions or powers off, the Call Divert feature allows the radio to divert calls to a private or PABX/PSTN contact to ensure communications.

1. On the home screen, go to **Call Settings > Call Divert > On/Off**.
2. Enter the divert ID.

9.1.3 Security

Power-on Password

This feature allows you to set the power-on password of the radio. If you enter the wrong password for the preset consecutive times, the radio cannot be used normally. Contact your dealer to reset the password.

1. Go to **Security Settings > Power on Password > On/Off**.
2. Enter the password twice.
3. Select **Confirm**.

Encrypt

The Encrypt feature provides end-to-end encryption for voice and data to protect your voice and data against eavesdropping.

Turn On the Encrypt Feature

If the radio is preprogrammed with this feature by your dealer, you can turn on the Encrypt feature in either of the following ways:

- Go to **Security Settings > Encrypt > On/Off**, and then press .

- Press the preprogrammed **Encrypt** key.

NOTE

In conventional mode, the Encrypt feature is enabled for the current channel. When switching to the channel, the radio automatically enables encryption.

Set the Encrypt Feature

In conventional mode, you can add or select the encrypt key as follows:

- Add an Encrypt Key
 - Go to **Security Settings > Encrypt > New Key**.
 - Specify the key-related parameters, and then press .

The following table describes the key-related parameters.

Parameter	Description
Key ID	The ID for each key must be unique. The value ranges from 1 to 255.
Key Alias	The key alias is composed of letters, digits, and special characters.
Key Length	The key length can be 10 characters, 32 characters, or 64 characters.
Key Value	The key value is composed of digits and letters and within the key length.

- Select the Encrypt Key
 - Go to **Security Settings > Encrypt > Key List**.
 - Select the encrypt key.

In trunking mode, you can select the encryption type as follows:

- Go to **Security > Encrypt > Encrypt Service**, and then
- Set the encryption type to **Only Voice**, **Only Data**, or **Voice and Data**.

Man Down

The Man Down feature allows the radio to automatically enter the emergency mode in either of the following scenarios:

- The radio is inclined by an angle greater than the preset angle.
- The radio keeps motionless (including moving at a constant speed) longer than the preset time.

You can place the radio upright or move it to exit the emergency mode.

To turn on this feature, do either of the following:

- Go to **Security Settings** > **Man Down**, and then press .
- Press the preprogrammed **Man Down** key.

Lone Worker

The Lone Worker feature allows the radio to automatically send an emergency alarm to your companion or the control center in either of the following scenarios:

- You do not operate the radio within the preset time.
- The radio does not transmit voice within the preset time.

You can press the keys, rotate the knob, or transmit voice to exit the emergency mode.

To turn on this feature, do either of the following:

- Go to **Security Settings** > **Lone Worker**, and then press .
- Press the preprogrammed **Lone Worker** key.

TF Card Encryption

You can use a TF card to encrypt voice and data services.

When higher communication security is required, you can customize encryption algorithms and keys, and store them in the TF card. During communication, you can use the TF card for encryption.

When you use TF card encryption, hardware encryption of the radio should be configured.

TF Card Recorder

The Recorder feature allows you to record live sounds and calls to the TF card and manage the recording files stored in the TF card.

NOTE

The Recorder feature is preprogrammed by your dealer.

- Live recording



The Live Record feature allows you to record the sound in the current environment. The maximum recording time is 495 minutes.

- Turn on the Live Record feature

Go to **Menu** > **TF Application** > **Recorder** > **Live Record**, and then press  to turn on the feature.

- Stop recording





- Press .

- The radio automatically exits the recording when other services with higher priority occurs or the storage of the TF card is insufficient.
- Call recording
 - Turn on the Call Record feature
 - Press the preprogrammed **Call Record** key.
 - Go to **Menu > TF Application > Recorder > Call Record**, and then press  to turn on the feature.
 - Stop recording
 - Go to **Menu > TF Application > Recorder > Call Record**, and then press  to turn off the feature.
 - The radio automatically exits the recording when other services with higher priority occurs or the storage of the TF card is insufficient.
- Recording file management

The File List feature allows you to manage recording files stored in **Record File List**. The file and file folder are described in the following table.

Item	Description	Naming Convention
Recording file	The maximum duration of each recording file is five minutes. If the duration exceeds the limit, the recording file is divided into several files.	<p>The recording file is named as "xyyy_mmddhhmmss.zz".</p> <ul style="list-style-type: none"> ● "x" can be "R" or "C", representing live recording and call recording respectively. ● "yyy" is the number of a call. ● "mmddhhmmss" represents the recording time (month/day/hour/minute/second). <ul style="list-style-type: none"> ➤ In trunking mode, the time is the real time provided by the clock. ➤ In conventional mode, the time is "0000000000". ● "zz" represents the serial number of the files separated from a file.
Recording file folder	Each folder can store up to 200 recording files.	<p>The folder is named as "Record_xxxx xxxx".</p> <p>The folder number "xxxx" ranges from 0001 to 9999.</p>

To manage the recording files, do one of the following:

- To play back a recording file, select **Play**, and then press .
- To view the details of a recording file, select **View**, and then press .
- To delete a recording file, select **Delete**, and then press .
- To edit the name of a recording file, select **Edit**, enter the new name, and then press .

NOTE

- With the Auto Cover feature preprogrammed by your dealer, the radio automatically deletes the earliest recording file when the storage of the TF card is full.
 - With the Compression feature preprogrammed by your dealer, the radio compresses the recording file without affecting the audio quality to save the storage of the TF card.
-



9.1.4 Check the Product Information

- On the home screen, go to **Menu > Settings > Device Information**, and then do any of the following:
 - Select **Device Status**, and then check the information of battery and TF card.
 - Select **Radio Information**, and then check the radio ID, serial number, model name, frequency range, and so on.
- With the QR Code feature preprogrammed by your dealer, select **ScanCode Download**, and then scan the QR code to quickly obtain the radio information.

9.2 Contacts

9.2.1 Create a Contact

Through Contact Menu

- In conventional mode, go to **Menu > Contact > Contact > New Contact**, enter the alias and private ID/phone number, and then press .
- In trunking mode, go to **Menu > Contact > Private > New Contact**, enter the alias and private/PSTN/PABX ID, and then press .

NOTE

The alias and ID/number of each contact must be unique.

Through Call Logs

You can save a private ID to the contact list from the call logs. Do as follows:

1. On the home screen, go to **Menu > Call Logs**.

2. Select the call log.
3. Select **New Contact** or **Add To Contact**, and then press .

9.2.2 Edit a Favorite Contact

On the home screen, go to **Menu > Contact > Favorite**, or press the preprogrammed **Favorite Contact List** key to enter the favorite contact list, and then do any of the following:

- Select the favorite contact to view details or delete it.
- Select **Edit** to add or delete favorite contacts, and add or delete folders.
- In trunking mode, select a folder, select **Folder Management**, and then do any of the following:
 - Select **Add Contact** to add favorite contacts.
 - Select **Add File** to add subfolders.
 - Select **Delete Folder** to delete the folder.
 - Select **Delete All Contact** to delete all the contacts in the current folder.
 - Select **Delete All File** to delete all subfolders.

9.2.3 Priority Group (Trunking Only)

With the Priority Group feature preprogrammed by your dealer, you can set the priority level of groups. When receiving a group service request in a voice call, the radio preferentially participates in the service of the group with a higher priority.

To turn on this feature, go to **Menu > Settings > Group Settings > Priority Group > On/Off**.

You can set the priority of the group to level 1, level 2, or level 3. Larger number represents higher priority.

9.3 Profiles

The Profiles feature allows you to set the audio, alert tone, and vibration of the radio to suit your preference and work environments. The profiles include **General**, **Meeting**, **Outdoor**, **Covert Mode**, and custom mode.

- **General**: This profile is applicable to the low-noise environment, such as a quiet street.
- **Meeting**: This profile is applicable to the indoor environment that is relatively quiet.
- **Outdoor**: This profile is applicable to the high-noise environment, such as a highway.
- **Covert Mode** (preprogrammed by your dealer): This profile is applicable to special situations. The radio locks the screen and disables all alert tones and LED indications. The radio uses only an audio accessory to output voice.

- Custom: This profile is applicable to other situations.

9.3.1 Switch the Profile

- On the home screen, go to **Menu > Profiles**, and then select the profile.
- Press the preprogrammed **Profiles Switch** key.
- Press the **One Touch Call/Menu** key, and then select the profile.

9.3.2 Set the Alert Tone

1. On the home screen, go to **Menu > Profiles**, and then select the profile.

The corresponding **Setting** tab is displayed.

2. Go to **Setting > Tone**, and then do the following:

If You Want To...	Then...
Set all alert tones	<ul style="list-style-type: none"> ● Select Radio Tone to turn on or off all alert tones. ● Select Radio Tone Volume, and then select the volume level. Higher level represents higher volume.
Set a single alert tone	<ol style="list-style-type: none"> 1. Select Single Tone. 2. Select a kind of alert tone, and then do as follows: <ul style="list-style-type: none"> ➤ Select On/Off to turn on or off the alert tone. ➤ Select Tone Volume, and then select the volume level. Larger number represents higher volume.

9.3.3 Mic AGC

The Mic AGC feature allows the calling radio to control the voice output gain within a proper range during transmission, so as to provide improved voice with proper volume for the called radio. This feature ensures stable voice even in noisy environment.

With the Mic AGC feature preprogrammed by your dealer, go to **Menu > Profiles > Setting > Audio Set > Digital Mic AGC/Analog Mic AGC**, and then press .

9.3.4 Audio Mode

The Audio Mode feature allows the radio to adjust the strength of the audio signal upon receiving voice. In this way, this feature optimizes the quality of the received voice, and meets user demands in different scenarios.

Set the low/mid/high frequency gain as follows:

1. On the home screen, go to **Menu > Profiles > Setting > Audio Set > Audio Mode**.
2. Select the audio mode, or **User Defined**.
3. (Optional) If you select **User Defined**, select **Low Freq. Gain**, **Mid Freq. Gain**, and **High Freq. Gain**, and then select a value.

Noise Cancellation

The Noise Cancellation feature allows the radio to automatically eliminate ambient noise when receiving or transmitting voice. This feature enhances the voice clarity, while also decreases the volume.

With this feature preprogrammed by your dealer, to turn on the feature, do either of the following:

- On the home screen, go to **Menu > Profiles > Setting > Audio Set > Noise Cancellation**, and then press .
- Press the preprogrammed **Noise Cancellation** key.





9.4 Scan

9.4.1 Conventional Mode

In conventional mode, the Scan feature allows you to listen to activities on other channels, keeping track of your team members.

Turn on the Scan Feature

- On the home screen, go to **Menu > Scan > Scan On/Off**, and then press .
- Press the preprogrammed **Scan** key.

With this feature enabled, the radio scans according to the scan list preset for the current channel. The LCD displays , and the LED indicator flashes orange slowly. When detecting activities on a channel, the radio stays on the channel. The LED indicator glows green. If the radio stays on a non-priority channel, the LCD displays . If the radio stays on Priority Channel 1 or Priority Channel 2, the LCD displays  or .

NOTE

If you do not want to hear activities on the channel, press the preprogrammed **Nuisance Temporary Delete** key to remove the channel from the scan list temporarily.

Set the Scan List

The scan list is a list of up to 32 channels that the radio scans, which includes analog channels and digital channels.

On the home screen, go to **Menu > Scan**, select the scan list, and then do any of the following:

- Select **Add CH** to add a new channel to the list.
- Select **Set Default** to set the list as the default scan list for the current channel.
- Select **View Record** to view or manage all channels on the current list.

If you do not need to scan, you can delete all channels other than the current channel. If you want to preferentially hear the activities on a channel, you can select the channel, and then select **Set PrioCH-1** or **Set PrioCH-2**.

9.4.2 Trunking Mode

Pre-registration Hunt

Before registering, the radio hunts through the control channels for available BSs. Two hunting plans are adoptable: Fixed Trunking Station Control Channel (Fixed TSCC) and Flexible Trunking Station Control Channel (Flexible TSCC). When the radio has unified frequency plans, it can use the Fixed TSCC. When the radio does not have unified frequency plans, it can use the Flexible TSCC.

If the radio is preprogrammed with Fixed TSCC, you can select the following modes:

Hunt Mode	Description	Operation
Short Hunt	The radio hunts the latest 10 registered channels. If the radio fails to register with any of those channels, it continues to hunt channels from near BS and the fixed TSCC hunt list until successful registration.	On the home screen, go to Menu > Scan > TSCC Hunt , and then select an appropriate mode.
Comprehensive Hunt	If the radio fails to register during short hunt, the radio will initiate comprehensive hunt, which allows the radio to hunt all the channels within the preset frequency range. During comprehensive hunt, the radio performs a short scan every 200 channels until successful registration.	
Team Hunt	The radio hunts the latest 10 registered channels. If the radio fails to register with any of those channels, it continues to hunt channels from near BS and the fixed TSCC team hunt list until successful registration.	

Post-registration Hunt

After successful registration, you can press the preprogrammed **Manual Current Hunt** key to hunt again. To ensure seamless communications, you can enable the following hunt modes:

Hunt Mode	Description	Operation
Background Hunt	This feature allows an idle radio to keep detecting the signal strength of the BS with which it registers. If the signal strength goes below the threshold level preset by the dealer, the radio will automatically hunt for an adjacent BS with stronger signal strength and register with it.	<ul style="list-style-type: none"> ● On the home screen, go to Menu > Scan, and then turn on Background Hunt, Home Sta. Hunt, or Handover. ● Press the preprogrammed Background Hunt, HomeStation Hunt, or Multi-site Handover key.
Home Station Hunt	In a BS overlapping area, this feature allows the radio operating on another channel to switch back to the home station channel when its signal strength reaches the preset threshold. It is recommended that you set your frequently used channel as the home station channel.	
Handover	The signal strength received from a BS may fluctuate due to position change and affect the communication quality of the radio. On such occasions, this feature allows the radio to automatically register with the BS with stronger signal.	
Vote Now	This feature allows the radio in idle to check the signal strength of the BS assigned in a broadcast call, and decide whether to register with the BS.	This feature is enabled by default.

9.5 Positioning

The Positioning feature allows you to collect the position information of the radio through satellites.

 **NOTE**

This feature applies only to radios with GPS, COMPASS, or GLONASS.

9.5.1 Turn on the Positioning Feature

- In conventional mode, go to **Menu > Position > GPS On/Off, COMPASS On/Off, or GLONASS On/Off**, and then press .
- In trunking mode, this feature is preprogrammed by your dealer.

9.5.2 Select the Positioning System

The radio supports the following positioning systems:

- GPS
- COMPASS/GLONASS
- COMPASS/GLONASS+GPS

To select the positioning system, go to **Menu > Position > Position Sys.**

 **NOTE**

This feature applies only to radios with COMPASS or GLONASS.

9.5.3 View the Position



- Local Position

On the home screen, go to the **Menu > Position > Position**, and then view the position information of your radio (including longitude, latitude, time, date, and the number of satellites).
- Contact Position
 - In conventional mode, go to **Menu > Position > Query Location > Contact List or Manual Dial**, and then view the location information of a nearby private contact (including alias, direction, and distance).
 - In trunking mode, go to **Menu > Position > Query Neighbors**, and then view the location information of a nearby private or group contact (including alias, direction, and distance). The feature is preprogrammed by your dealer.



9.5.4 Send a Position Message

In conventional mode, you can send a position message to a contact. Do as follows:

1. On the home screen, go to **Menu > Position > Position > GPS Msg.**
-

2. Press  to enter the contact list, and then select the contact.
3. Press  to send the message to the contact.

In trunking mode, you can send a position message to the dispatch station (The feature is preprogrammed by your dealer). Do as follows:

1. Go to **Menu > Position > Msg with Position**.
2. Press  to enter the message-editing interface.
3. Edit the message.
4. Press  to send the message.

9.5.5 Call Location

During a call, if the transmitting radio is enabled with the Call Location feature, the receiving radio displays the location information of the transmitting radio when receiving valid positioning data.

Voice w/Location

The Voice w/Location feature allows the radio to report its location information when initiating a private call, a group call, or an emergency call.

On the home screen, go to **Menu > Position > Call Location > Voice w/Location**, and then press .

Display Call Location

If the transmitting radio is enabled with the Voice w/Location feature and the receiving radio is enabled with the Display Call Location feature, the receiving radio displays the location information of the transmitting radio during a call.

1. On the home screen, go to **Menu > Position > Call Location > Display Call Location**, and then press .
2. On the home screen, go to **Menu > Position > Call Location > Display Type**, and then select **16 Azimuth & Dist.**, **Accur Azimuth & Dist.**, or **Talker Location**.

GPS Report

The GPS Report feature allows the radio to report its location information to the control center or trunking system.

- **Conventional Mode**

In conventional mode, you can report the GPS data to the control center by pressing the preprogrammed **GPS Report** key. Alternatively, you can consult your dealer to configure the GPS trigger, allowing the radio to automatically report the GPS data upon power-on/off, or according to the preset time or distance interval.

- **Trunking Mode**

In trunking mode, with the GPS Active Report feature preprogrammed by your dealer, the radio automatically reports the GPS data when reaching the preset time or distance.

If the radio is enabled with the GPS Report in Voice feature, you can actively report GPS data during a call.

Quick GPS

Based on GPS standard time, the Quick GPS feature divides the GPS upload time into several equal-length time slices. These time slices are allocated to radios of different configurations for periodic upload and single upload. Each radio uses the same GPS upload time slice to upload GPS data, improving upload efficiency and reliability.

If your dealer configures the feature to a digital channel, the channel only reports the quick GPS data. The services of voice, short message, RRS, and conventional GPS report are not supported.

9.6 BT

CAUTION

- To derive optimal communication quality, we recommend that you use the BT devices approved by the Company.
- If BT earpieces of other companies are used, you must use them with the wireless ring PTT of the Company. Otherwise, transmission is unavailable through the earpieces.

BT is a wireless technology that supports short-distance communications and data exchange between devices. You can connect the radio to a BT device through the built-in BT module.

To turn on the BT feature, press the preprogrammed **BT** key, or go to **Menu > BT**. After this feature is enabled, the LED indicator flashes blue every 3 seconds.

NOTE

The BT feature applies only to radios with the BT module.

9.6.1 Connect a BT Device

1. Turn on the BT device and enter the pairing status. Refer to the accessory manual for details.
2. Search and connect to the BT device.
 - On the home screen, go to **Menu > BT > Manual Search > Match PTT/Match Earphone**, enter the MAC address, and then press .
 - Go to **Menu > BT > Auto Search**, and then select the BT device from the detected device list.

After the radio is connected to the BT device, the LED indicator of the radio flashes blue every 1.5 seconds.

9.6.2 BT Audio Switch

With the BT device connected, you can press the preprogrammed **BT Audio Switch** key to switch the audio output device between BT earpiece and the radio.

9.6.3 Set the BT

- Change BT Name

On the home screen, go to **Menu > BT > My Device > BT Devices Name**, enter the new name, and then press



- Set Visibility

On the home screen, go to **Menu > BT > My Device > Always Detected**, and then press .

Other BT devices can discover the radio.

- View BT Information

On the home screen, go to **Menu > BT > My Device > Device Information Detected**.

9.6.4 BT Location

The BT Location feature is an indoor positioning technology. When the radio detects the BT beacon message, the radio will send the BT information to the dispatcher.

With the BT Location feature preprogrammed by the dealer, go to **Menu > BT > BT Location** to turn on the feature.

9.7 One Touch Call/Menu

The One Touch Call/Menu feature allows you to quickly initiate a preset service by pressing the preprogrammed **One Touch Call/Menu** key.



The following table shows the services that can be implemented by this feature and the corresponding operations.

Mode	Description	Operation
Conventional Mode	<p>On an analog channel, you can initiate a call to a 2-tone contact.</p> <p>On a digital channel, you can do any of the following:</p> <ul style="list-style-type: none"> ● Initiate a group call, a private call, or an all call. 	<ul style="list-style-type: none"> ● Use the numeric keypad to initiate the service. <ol style="list-style-type: none"> Go to Menu > Settings > Basic Settings > Keypad Mode, and then select One Touch Call/Menu.

Mode	Description	Operation
	<ul style="list-style-type: none"> ● Send a quick text message or position message to a private or group contact. ● Initiate an alert call, radio check, remote monitor, radio enable, or radio disable service. ● Switch to a function menu or realize a function. 	<ul style="list-style-type: none"> b. On the home screen, press the numeric key to initiate the service. ● Press the preprogrammed One Touch Call/Menu key to initiate the service. <p> NOTE</p>
Trunking Mode	<ul style="list-style-type: none"> ● Initiate a group call, a private call, an all call, a broadcast call, or an emergency call. ● Send a quick text, a status message, or a user-defined message. ● Switch to a function menu or realize a function. 	<p>When initiating a call on a digital channel, you need to press and hold the PTT key after pressing the One Touch Call/Menu key.</p>

9.8 Quick Dial

On the home screen, the Quick Dial feature allows you to turn on or off a feature or switch to a function menu by manual dialing. This feature is available only when the keypad input is configured.

- In conventional mode and trunking mode, on the home screen, press a numeric key (0–9), and then press  to adjust the power level, set the backlight, switch the operation mode, check the radio information, or turn on or off the alert tone.
- In trunking mode, on the home screen, you can also press a numeric key (0–9), and then press  to view control channels. Additionally, you can enter several numbers, and then press  to switch the BS, control channel, system code, or current talk group. For details, consult your dealer.

 **NOTE**

In conventional mode, with the keypad input and Quick Dial feature enabled, you can do either of the following:

- On the home screen, enter "0", and the quick dial text box appears.
- Press  to switch between the contact text box and the quick dial text box.

On an analog channel, the radio displays only the quick dial text box.

9.9 Roam

9.9.1 Conventional Mode

In conventional mode, the Roam feature allows you to enjoy seamless communication across sites.

With the Roam feature preprogrammed by your dealer, you can do the following:

Turn On the Roam Feature

- On the home screen, go to **Menu > Roam > On/Off**, and then press .
- Press the preprogrammed **Roam** key

Set the Roam List

A roam list contains a group of channels under monitoring. Each list contains up to 32 channels.

On the home screen, go to **Menu > Roam > Roam List**, select a roam list, and then add or delete channels in the list.

9.9.2 Trunking Mode

The Roam feature allows the radio to be registered with a non-home BS or network when the radio is on move. When the radio detects signal, it initiates the registration.

This feature is preprogrammed by your dealer.

9.10 DGNA

The Dynamic Group Number Assignment (DGNA) feature allows you to initiate a call to or receive a call from a dynamic group temporarily created by a dispatch station. The created dynamic group is saved in a dynamic group menu on the radio.

The radio displays "DGNA Successful" when the dynamic group is added and "DGNA Deleted" when the dynamic group is deleted. You cannot use the dynamic group after the group is deleted.

For operations of initiating, answering, or ending a DGNA call, see [Group Call](#).

9.11 Priority Interrupt

The Priority Interrupt feature allows you to interrupt the ongoing activities (such as a call, a call hang status or remote monitor) on the current channel to release the channel, so as to initiate a new call or a new data service. This feature includes manual priority interrupt and auto priority interrupt.

9.11.1 Manual Priority Interrupt

Press the preprogrammed **Priority Interrupt** key to interrupt the ongoing activities.



9.11.2 Auto Priority Interrupt



Auto Priority Interrupt	Triggered When You...
Emergency Priority Interrupt	Make an emergency call.
Call Back Priority Interrupt	Press and hold the PTT key to call back.
Message Priority Interrupt	Send a message.
Radio Disable Priority Interrupt	Send the Radio Disable command.
All Call Priority Interrupt	Make an all call.

9.12 Emergency

The Emergency feature allows you to seek help from your companion or the control center in case of emergency. You can initiate an emergency call with the highest priority even when your radio is transmitting or receiving.

In emergency mode, the radio transmits at high power level by default. According to the emergency type preset by your dealer, the radio gives different indications. The available emergency types are as follows:

Emergency Type	Description
Siren Only	The radio emits a siren and displays  and  , but does not transmit any emergency signal to the control center.
Regular	The radio gives visible and audible indications.
Silent	The radio gives no visible and audible indication.
Silent w/Voice	The radio gives audible indications only upon receiving a call. Otherwise, the radio gives no audible or visible indication.

Emergency Type	Description
Alarm w/Siren	The radio transmits the emergency signal to the control center, and then emits a siren and displays  and  .

In addition, you can request your dealer to set one of the following emergency modes:

Emergency Mode	Description	Note
Call Only	It allows you to initiate an emergency call.	If the emergency type is Siren Only or Alarm w/Siren, you do not need to set the emergency mode.
Alarm w/Call	It allows you to send an emergency code and initiate an emergency call.	
Alarm	It allows you to send an emergency code.	

9.12.1 Initiate an Emergency Call

Press the preprogrammed **Emergency On** key to initiate an emergency call to the preset contact.

If the Alarm w/Call To Follow feature is preprogrammed by your dealer, you can speak into the microphone without pressing and holding the **PTT** key. If the preset voice cycles expire, you can press and hold the **PTT** key to initiate the emergency call again.

9.12.2 Answer an Emergency Call

You can answer an emergency call without any operation.

9.12.3 End an Emergency Call

The calling party can end an emergency call in either of the following ways:

- Press the preprogrammed **Emergency Off** key.
- Turn off the radio.

The called party can exit an emergency call by switching the channel or turning off the radio.

9.13 Stun, Revive, and Kill Conventional Mode

- Radio Disable

You can send the Radio Disable command to a private contact to disable its radio. The disabled radio is incapable of any function except being monitored remotely.

- Radio Enable

To restore the disabled radio to normal use, you can send the Radio Enable command to a private contact or send the radio to your dealer for reprogramming.

Trunking Mode

The Stun, Revive, and Kill features are preprogrammed by your dealer by default and triggered by the dispatch station or trunking system.

- Stun

When the radio is stunned by the dispatch station or trunking system, the radio displays "Radio Stunned". In this case, the radio cannot initiate or receive any network service (including calls and short messages), but retains features such as registration, revive, kill, and authentication.

- Revive

A stunned radio can restore to normal use when receiving the revive command from the dispatch station or trunking system. Then the radio displays "Revive Successful".

- Kill

When the radio is killed by the dispatch station or trunking system, the radio displays "Radio Killed". In this case, the radio is incapable of any function except power-on/off. To restore normal use, send the radio back to the Company.

9.14 Emergency Erase Data

The Emergency Erase Data feature allows the radio to erase encrypted data in case of emergency, so as to prevent unauthorized access. When erasing the data, the radio stops voice and data services and returns to the home screen.

If this feature is preprogrammed by your dealer, the encrypted data can be erased in the following cases:

- Press **SK1** and then the **PTT** key (within 1.5s) for two times, and then press **SK1** again.
- When the radio is killed, the data on the radio will be erased automatically.

10. Troubleshooting

Phenomena	Analysis	Solution
The radio cannot be turned on.	The battery may be installed improperly.	Remove and reattach the battery.
	The battery power may have run out.	Recharge or replace the battery.
	The battery may suffer from poor contact caused by dirtied or damaged battery contacts.	Clean the battery contacts.
The radio cannot be registered.	The radio cannot detect signal from the BS.	Make sure the radio is within the coverage of the BS.
	The radio may not be authorized.	Contact the BS manager to check if the radio is authorized in the network management system.
The radio is registered repeatedly.	The signal may be intermittent.	Make sure the radio is within the coverage of the BS.
The radio cannot establish a call.	The signal may be weak.	Make sure the radio is within the coverage of the BS.
No voice is heard after a call is established.	The radio ID may be repeated.	Contact the BS manager to check whether the radio ID is repeated in the network management system.
The called party disconnects repeatedly during communication.	The signal may be intermittent or weak.	Make sure the radio is within the coverage of the BS.
The voice is unclear.	The signal may be weak.	Make sure call participants are within the communication range.
	You may be interrupted by radios using the same frequency.	Change the frequency, or adjust the squelch level.

Phenomena	Analysis	Solution
There are unknown voices or sounds on the channel.	The radio may be set with no signaling.	Set signaling for all member radios to avoid interference at the same frequency.
The keys do not work.	The keys may fail to function temporarily.	Restart the radio.
The LCD does not display any information.	The LCD may fail to function temporarily.	Restart the radio.
The positioning system cannot locate your position.	The radio may be at an unfavorable position, so no position signal is received.	Move to an open and flat area, and try again.
The BT device cannot be paired.	The battery power of the BT device may be low.	Recharge the BT device.
	The BT device may be too far away from the radio.	Move the BT device towards the radio.
	The battery voltage may be low.	Recharge or replace the battery.
During receiving, the voice is weak, discontinuous, or totally inactive.	The volume may be low.	Increase the volume or contact your dealer to turn the Mic AGC feature off.
	The antenna may be loosened or installed improperly.	Turn the radio off, and then remove and reattach the antenna.
Communications with group members are unavailable.	The speaker may be blocked or damaged.	Clean the surface of the speaker.
	The frequency or signaling type may be inconsistent with that of other members.	Set your TX/RX frequency and signaling to the same as that of other members.
	The channel type (digital/analog) may be set inconsistently.	Make sure all members are on the same digital/analog channel.

Phenomena	Analysis	Solution
	You may be too far away from the group members.	Move towards other members.
	The signal may be weak.	Make sure call participants are within the communication range.
There is too much noise and hiss.	<p>The signal may be weak.</p> <p>The radio may be in an unfavorable position. For example, the signal may be blocked by high-rise buildings or frustrated in the underground areas.</p> <p>The radio may suffer from external disturbance (such as electromagnetic interference).</p>	<p>Make sure call participants are within the communication range.</p> <p>Move to an open and flat area, and restart the radio.</p> <p>Stay away from the equipment that may cause interference.</p>

If the above solutions cannot solve your problems, or you may have some other queries, please contact the Company or your local dealer for more technical support.

11. Radio Care

To guarantee optimal performance as well as a long service life of the radio, follow the tips below.

11.1 Care

Radio

CAUTION

- Do not care or clean the radio in a hazardous area.
 - If the radio is wet inside, do not turn on it. Contact the dealer or maintenance center in time.
-

- Do not disassemble the radio.
- Do not throw, crack, or hammer the radio.
- Do not pierce or scrape the radio, especially the interfaces.
- Do not expose the radio to the extreme temperature.
- Keep the radio away from substances that can corrode it.
- Close the accessory connector cover when no accessory is in use.
- Do not connect the radio to other incompatible radio.
- Do not hold the radio by its antenna.

To avoid liquid penetration into the radio, follow the tips below:

- Do not expose the radio to the environment with high temperature and high humidity.
- Keep the radio away from salty water, ionized water, alcoholic beverage, lotion, or other impure water.
- Before connecting the accessory or charger to the radio, ensure the radio and the interface are dry.

If the radio has been wet, follow the tips below:

- Do not turn on the radio.
- Do not connect the accessory or charger to the radio.
- Do not dry the radio by microwave, hair dry, or other external heat sources.
- Do not insert the cotton buds or tissue into the interface.
- Use the clean and soft cloth to dry the water on the radio surface, and then put the radio to the well-ventilated place until it is dry.

Battery

To guarantee optimum performance as well as a long service life of the battery, follow the tips below:

- Use the approved charger to charge the battery.

- Keep the radio turned off during charging.
- Do not use the radio during charging.
- Charge the battery under the temperature from 0°C to 40°C.
- When the low battery alert occurs, replace or charge the battery in time.
- When the battery is fully charged, disconnect the charger in time.
- Do not drop the battery by force.
- Do not make the battery wet.
- To avoid short circuit, do not use the conductive substance such as iron wire to touch the anode and cathode of the battery.

11.2 Cleaning

CAUTION

- Turn off the radio and remove the battery before cleaning.
- Ensure no external radios are connected to the radio.
- Do not use chemical preparations such as stain removers, alcohol, sprays or oil preparations.
- Do not directly spray the neutral cleanser on the radio.
- Do not use the radio before it is fully dry.
- After cleaning the accessory connector, put the cover back in place.

It is recommended to clean the radio regularly. During cleaning, you can check whether the components are damaged. If damages exist, contact the local dealer or the Company.

1. Use the non-metal brush to clean up the dust or dirt on the radio surface.
2. Use the lint-free cloth with proper neutral cleanser to clean the surface, screen, keys, knob, and interfaces.
3. Use another lint-free cloth with proper pure water to clean up the cleanser or residue.

 **NOTE**

If you want to clean the battery slot, use the non-metal brush to clean up the dust or dirt, and then use the dry and soft lint-free cloth to clean up the battery contacts.

11.3 Sterilizing

 **CAUTION**

- Turn off the radio and remove the battery before sterilizing.
 - Ensure no external radios are connected to the radio.
 - Do not directly spray the alcohol on the radio.
 - Keep the radio away from the power supply and fire.
 - Do not use the radio before it is fully dry.
 - After sterilizing the accessory connector, put the cover back in place.
-

It is recommended to sterilize the radio regularly. You can sterilize the radio by the following tips:

Use the lint-free cloth with proper rubbing alcohol (density $\geq 70\%$) to clean the radio surface, screen, knob, keys, and interfaces.

11.4 Storing

 **CAUTION**

- Turn off the radio and remove the battery before storage.
 - Ensure no external radios are connected to the radio.
 - The capacity and performance of the battery may degrade if the battery is not used for long time.
-

When storing the radio, follow the tips below:

- Keep the radio in the well-ventilated place with the temperature from -5°C to $+25^{\circ}\text{C}$ and the humidity from 45% to 75%.
 - Keep the radio away from the acidic and corrosive substances.
 - Keep the radio away from the fire or other heat sources.
 - Do not store the radio in direct sunlight.
 - During storing, charge the battery once every three months, and care the battery once every six months.
-

12. Optional Accessories

 **CAUTION**

Use the accessories approved by the Company only. Otherwise, we will not be liable for any loss or damage arising out of the use of unauthorized accessories.

Contact your local dealer for the optional accessories used with the product.

13. Specifications

Item	Description
Frequency Range	<ul style="list-style-type: none"> ● 136–174 MHz ● 400–480 MHz
Channel Capacity	1,024
Channel Spacing	12.5 kHz/20 kHz/25 kHz
Operating Voltage	7.4 V DC
Explosion-proof Rating	<ul style="list-style-type: none"> ● HP79XEx IIA <ul style="list-style-type: none"> ➢ Ex ib I Mb ➢ Ex ib IIA T4 Gb ➢ Ex ib IIIC T120°C Db ● HP79XEx IIC <ul style="list-style-type: none"> ➢ Ex ib I Mb ➢ Ex ib IIC T4 Gb ➢ Ex ib IIIC T120°C Db
Sensitivity	<ul style="list-style-type: none"> ● Analog: 0.16 μV (12 dB SINAD); 0.14 μV (Typical) (12 dB SINAD) ● Digital: 0.16 μV/BER5%
RF Output Power	<ul style="list-style-type: none"> ● HP79XEx IIA: 136–174 MHz: 5 W/1 W; 400–480 MHz: 4 W/1 W ● HP79XEx IIC: 2 W/1 W
Rated Audio Output Power	0.5 W
Rated Audio Distortion	$\leq 3\%$
Operating Temperature	<ul style="list-style-type: none"> ● Non-Ex area: $-30\text{ }^{\circ}\text{C}$ to $+60\text{ }^{\circ}\text{C}$ ● Ex area: $-25\text{ }^{\circ}\text{C}$ to $+60\text{ }^{\circ}\text{C}$
Storage Temperature	$-40\text{ }^{\circ}\text{C}$ to $+85\text{ }^{\circ}\text{C}$
Ex Battery	BL2105-Ex (2,150 mAh)
Battery Life (5-5-90 duty cycle)	<ul style="list-style-type: none"> ● HP79XEx IIA <ul style="list-style-type: none"> ➢ With Location enabled: 19 h ➢ With Location disabled: 22 h ● HP79XEx IIC

Item	Description
	<ul style="list-style-type: none"><li data-bbox="560 331 938 360">➤ With Location enabled: 21 h<li data-bbox="560 389 943 418">➤ With Location disabled: 24 h

 **NOTE**

All specifications are subject to changes without notice.

14. Abbreviations

Abbreviation	Full Name
AGC	Automatic Gain Control
DTMF	Dual-tone Multi-frequency
ESN	Electronic Serial Number
FOACSU	Full Off Air Call Set-Up
GPS	Global Positioning System
LCD	Liquid-Crystal Display
LED	Light-Emitting Diode
OACSU	Off Air Call Set-Up
PABX	Private Automatic Branch Exchange
PSTN	Public Switched Telephone Network
PTT	Push-To-Talk
SK	Side Key
TF	TransFlash
TK	Top Key
UI	User Interface



is the trademark or registered trademark of Hytera Communications Corporation Limited.

© 2023 Hytera Communications Corporation Limited. All Rights Reserved.

Address: Hytera Tower, Hi-Tech Industrial Park North, 9108# Beihuan Road, Nanshan District,
Shenzhen, People's Republic of China

Postcode: 518057

<https://www.hytera.com>